

DAPA Spline

manufactured for every climate



Testing by independent laboratories proves that Lincoln Sentry DAPA Spline has a UV resistance far superior to other spline products. This means that customers can rely on excellent long term performance over all temperature variations, as it doesn't harden in colder months / climates or excessively soften in warmer months / climates, which keeps mesh tight in any climate.

The flexibility and durability of the Lincoln Sentry DAPA Spline allows for easy insertion and cornering. As a result, the user friendliness of Lincoln Sentry DAPA Spline reduces assembly time, injury and helps prevent operator fatigue.

Aluminium Security Systems

Aluminium Screening Extrusions _____	C.2
Aluminium Diamond Grille _____	C.12



Security Products

Aluminium Security Systems

ALUMINIUM SCREENING EXTRUSIONS

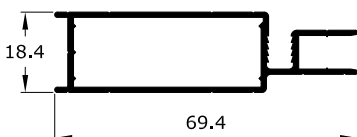

STANDARD SECURITY DOOR FRAME

- 6m lengths

Colour Name	Code
Mill Finish	3-000-100
White	3-000-116
Magnolia	3-000-124
Notre Dame	3-000-142
Natural Anodised	3-000-111
Black	3-000-117
Mountain Blue	3-000-127
Woodland Grey	3-000-143
Bronze Anodised	3-000-112
Primrose	3-000-119
Stone Beige	3-000-128
Hammersley Brown	3-000-113
Paperbark/Merino	3-000-121
Mist Green	3-000-129
Pottery	3-000-114
Citi Pearl	3-000-122
White Birch	3-000-141

Note: All aluminium extrusions or colours are not stocked in all locations, please contact your local branch for availability.

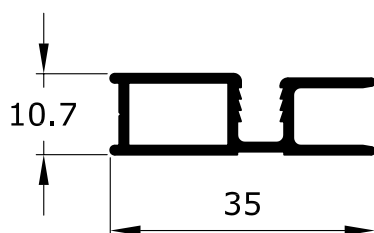

SECURITY SCREEN FRAME

- 6m lengths

Colour Name	Code
Mill Finish	3-001-300
White	3-001-316
Natural Anodised	3-001-311
Black	3-001-317
Stone Beige	3-001-328
Bronze Anodised	3-001-312
Primrose	3-001-319
White Birch	3-001-341

Note: All aluminium extrusions or colours are not stocked in all locations, please contact your local branch for availability.

Aluminium Security Systems

ALUMINIUM SCREENING EXTRUSIONS

9mm FLYSCREEN FRAME EXTRUDED

- 5m lengths

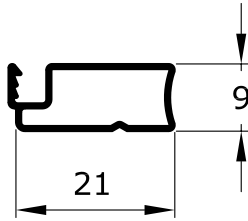

Colour Name	Code
Mill Finish	3-000-800
White	3-000-816
Woodland Grey	3-000-843
Natural Anodised	3-000-811
Black	3-000-817
Stone Beige	3-000-828
Bronze Anodised	3-000-812
Primrose	3-000-819
Hammersley Brown	3-000-813
Paperbark/Merino	3-000-821
White Birch	3-000-841

Note: All aluminium extrusions or colours are not stocked in all locations, please contact your local branch for availability.

11mm FLYSCREEN FRAME EXTRUDED

- 5m lengths

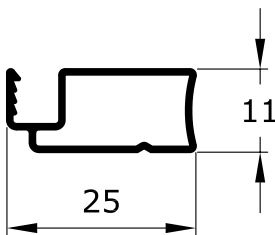

Colour Name	Code
Mill Finish	3-001-800
White	3-001-816
Natural Anodised	3-001-811
Black	3-001-817
Woodland Grey	3-001-843
Bronze Anodised	3-001-812
Primrose	3-001-819
Stone Beige	3-001-828
Hammersley Brown	3-001-813
Paperbark/Merino	3-001-821
White Birch	3-001-841

Note: All aluminium extrusions or colours are not stocked in all locations, please contact your local branch for availability.

Aluminium Security Systems

ALUMINIUM SCREENING EXTRUSIONS

SECURITY FRAME MID RAIL

Features:

- Mid rail with grille grooves
- 4.2m lengths

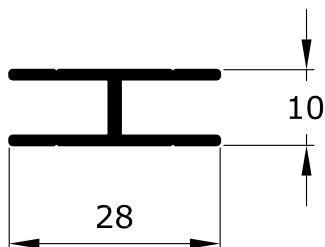

Colour Name	Code
Mill Finish	3-005-900
White	3-005-916
Natural Anodised	3-005-911
Black	3-005-917
Woodland Grey	3-005-943
Bronze Anodised	3-005-912
Primrose	3-005-919
Stone Beige	3-005-928
Hammersley Brown	3-005-913
Paperbark/Merino	3-005-921
White Birch	3-005-929

Note: All aluminium extrusions or colours are not stocked in all locations, please contact your local branch for availability.

SECURITY FRAME MID RAIL WITH SPLINE GROOVE

- Mid rail with grille and spline groove

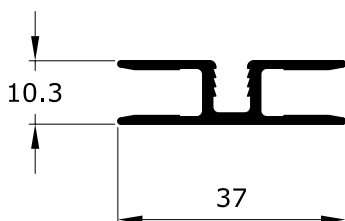

Colour Name	Code
Mill Finish	3-005-300
White	3-005-316
Stone Beige	3-005-328
Natural Anodised	3-005-311
Black	3-005-317
Bronze Anodised	3-005-312
Primrose	3-005-319
White Birch	3-005-341
Hammersley Brown	3-005-313
Paperbark/Merino	3-005-321
Woodland Grey	3-005-343

Note: All aluminium extrusions or colours are not stocked in all locations, please contact your local branch for availability.

Aluminium Security Systems

ALUMINIUM SCREENING EXTRUSIONS

SECURITY DOOR JAMB ADAPTOR

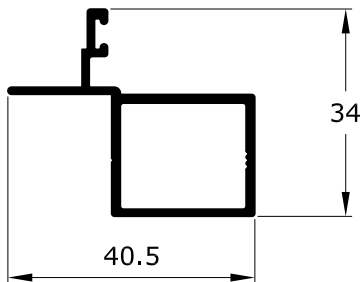

Features:

- Used to build out the position of a security door on the house entry (brick, block, timber)
- 5.1m lengths

Colour Name	Code
Mill Finish	3-002-600
White	3-002-616
Natural Anodised	3-002-611
Black	3-002-617
Woodland Grey	3-002-643
Bronze Anodised	3-002-612
Primrose	3-002-619
Stone Beige	3-002-628
Hammersley Brown	3-002-613
Paperbark/Merino	3-002-621
White Birch	3-002-641

Note: All aluminium extrusions or colours are not stocked in all locations, please contact your local branch for availability.

16mm BUG SEAL HOLDER - ALUMINIUM

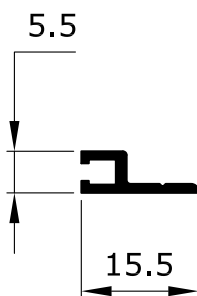

Features:

- Used on hinge and sliding door
- 4.2m lengths

Colour Name	Code
Mill Finish	3-175-110
Mill Finish *Pre punched	3-175-110P
White	3-175-116
Magnolia	3-175-124
Notre Dame	3-175-142
Natural Anodised	3-175-111
Black	3-175-117
Mountain Blue	3-175-127
Woodland Grey	3-175-143
Bronze Anodised	3-175-112
Primrose	3-175-119
Stone Beige	3-175-128
Hammersley Brown	3-175-113
Paperbark/Merino	3-175-121
Mist Green	3-175-129
Pottery	3-175-114
Citi Pearl	3-175-122
White Birch	3-175-141

Note: All aluminium extrusions or colours are not stocked in all locations, please contact your local branch for availability.

Aluminium Security Systems

ALUMINIUM SCREENING EXTRUSIONS

G

Security Products

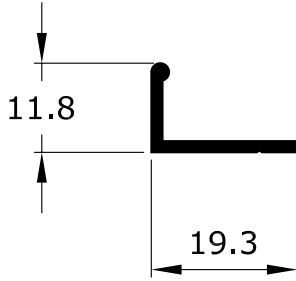

DVA ANGLE

Features:

- Used with DVA one way mesh
- 2.8m lengths

Colour Name	Code
Mill Finish	3-004-900
White	3-004-916
Magnolia	3-004-924
Notre Dame	3-004-942
Natural Anodised	3-004-911
Black	3-004-917
Mountain Blue	3-004-927
Woodland Grey	3-004-943
Bronze Anodised	3-004-912
Primrose	3-004-919
Stone Beige	3-004-928
Hammersley Brown	3-004-913
Paperbark/Merino	3-004-921
Mist Green	3-004-929
Pottery	3-004-914
Citi Pearl	3-004-922
White Birch	3-004-941

Note: All aluminium extrusions or colours are not stocked in all locations, please contact your local branch for availability.

STANDARD INTERLOCK

Features:

- Used in sliding door applications
- 2.4m lengths

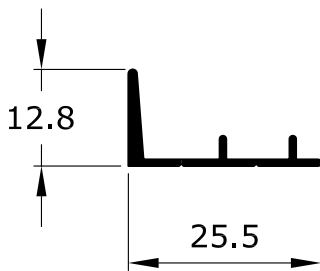

Colour Name	Code
Mill Finish	3-175-500
White	3-175-516
Magnolia	3-175-524
Notre Dame	3-175-542
Natural Anodised	3-175-511
Black	3-175-517
Mountain Blue	3-175-527
Woodland Grey	3-175-543
Bronze Anodised	3-175-512
Primrose	3-175-519
Stone Beige	3-175-528
Hammersley Brown	3-175-513
Paperbark/Merino	3-175-521
Mist Green	3-175-529
Pottery	3-175-514
Citi Pearl	3-175-522
White Birch	3-175-541

Note: All aluminium extrusions or colours are not stocked in all locations, please contact your local branch for availability.

Aluminium Security Systems

ALUMINIUM SCREENING EXTRUSIONS

3mm INTERLOCK

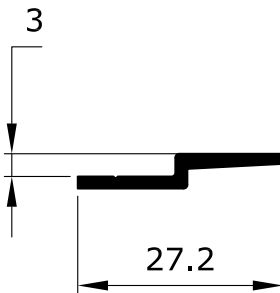

Features:

- Used in sliding door applications
- 2.4m lengths

Colour Name	Code
Mill Finish	3-175-600
White	3-175-616
Magnolia	3-175-624
Notre Dame	3-175-642
Natural Anodised	3-175-611
Black	3-175-617
Mountain Blue	3-175-627
Woodland Grey	3-175-643
Bronze Anodised	3-175-612
Primrose	3-175-619
Stone Beige	3-175-628
Hammersley Brown	3-175-613
Paperbark/Merino	3-175-621
Mist Green	3-175-629
Pottery	3-175-614
Citi Pearl	3-175-622
White Birch	3-175-641

Note: All aluminium extrusions or colours are not stocked in all locations, please contact your local branch for availability.

7mm INTERLOCK

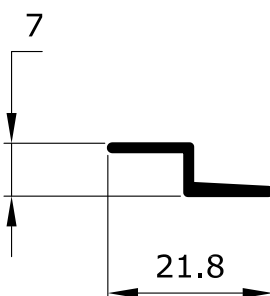

Features:

- Used in sliding door applications
- 2.4m lengths

Colour Name	Code
Mill Finish	3-175-400
White	3-175-416
Black	3-175-417
Primrose	3-175-419
Stone Beige	3-175-428
White Birch	3-175-441

Note: All aluminium extrusions or colours are not stocked in all locations, please contact your local branch for availability.

Aluminium Security Systems

ALUMINIUM SCREENING EXTRUSIONS

G

Security Products

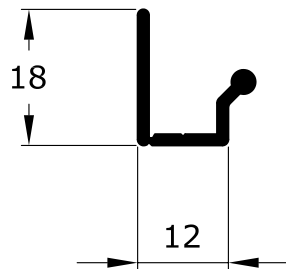

SECURITY DOOR TRACK "J TRACK"

Features:

- Used in sliding door applications
- 1.5mm wall thickness
- 5.4m lengths

Colour Name	Code
Mill Finish	3-004-300
White	3-004-316
Black	3-004-317
Primrose	3-004-319
Stone Beige	3-004-328
White Birch	3-004-341

Note: All aluminium extrusions or colours are not stocked in all locations, please contact your local branch for availability.

FLYSCREEN FRAME EXTENSION

Features:

- Used on awning windows with winder
- Used with 9mm or 11mm flyscreen frames
- Snap off groove location
- 5m lengths

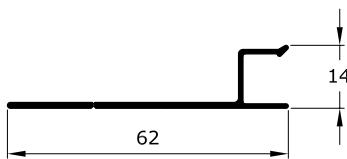

Colour Name	Code
Mill Finish	3-002-000
White	3-002-016
Natural Anodised	3-002-011
Black	3-002-017
Woodland Grey	3-002-043
Bronze Anodised	3-002-012
Primrose	3-002-019
Stone Beige	3-002-028
Hammersley Brown	3-002-013
Paperbark/Merino	3-002-021
White Birch	3-002-041

Note: All aluminium extrusions or colours are not stocked in all locations, please contact your local branch for availability.

Aluminium Security Systems

ALUMINIUM SCREENING EXTRUSIONS

SLIDING DOOR TRACK

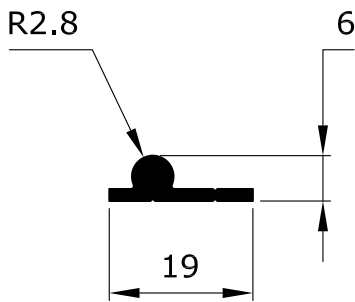

Features:

- Used in sliding door applications
- 5.4m lengths
- Pre-punched tracks are 5.3m lengths

Colour Name	Code
Mill Finish	3-291-304
Natural Anodised *Pre punched	3-291-297
Black	3-291-301
Bronze Anodised *Pre punched	3-291-302
Bronze Anodised	3-291-303
Natural Anodised	3-291-298
White *Pre punched	3-291-295

Note: All aluminium extrusions or colours are not stocked in all locations, please contact your local branch for availability.

SLIDING DOOR TRACK COVER

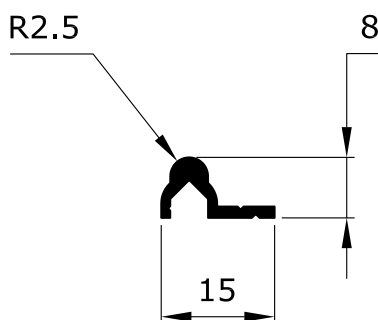

Features:

- Used to repair existing worn tracks
- 4.3m lengths

Colour Name	Code
Mill Finish	3-291-401
Black	3-291-417
Natural Anodised	3-291-400
Primrose	3-291-419
Bronze Anodised	3-291-402
Stone Beige	3-291-428
Hammersley Brown	3-291-413
White Birch	3-291-441
White	3-291-416

Note: All aluminium extrusions or colours are not stocked in all locations, please contact your local branch for availability.

Aluminium Security Systems

ALUMINIUM SCREENING EXTRUSIONS

25 X 20 ANGLE

Features:

- 1.6mm wall thickness
- 4.2m lengths

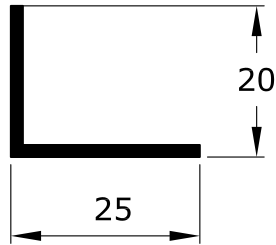

Colour Name	Code
Mill Finish	3-000-900
Primrose	3-000-919
Natural Anodised	3-000-911
Pottery	3-000-914
Stone Beige	3-000-928
White	3-000-916
Mist Green	3-000-929
Black	3-000-917
White Birch	3-000-941

Note: All aluminium extrusions or colours are not stocked in all locations, please contact your local branch for availability.

25 X 25 CHANNEL

Features:

- Used as a head channel in sliding door applications
- Suits security door top guide 3-182-490
- 1.5mm wall thickness
- 5.4m lengths

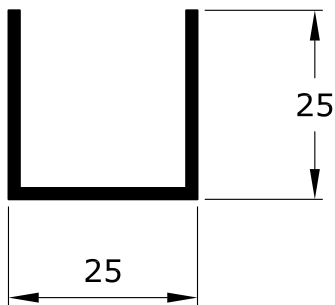

Colour Name	Code
Mill Finish	3-008-600
White	3-008-616
Stone Beige	3-008-628
Natural Anodised	3-008-611
Black	3-008-617
Mist Green	3-008-629
Primrose	3-008-619
White Birch	3-008-641
Pottery	3-008-614
Woodland Grey	3-008-643

Note: All aluminium extrusions or colours are not stocked in all locations, please contact your local branch for availability.

Aluminium Security Systems

ALUMINIUM SCREENING EXTRUSIONS

28 X 16 CHANNEL

Features:

- Used as a head or receiver channel in sliding door applications
- 1.6mm wall thickness
- 4.2m lengths

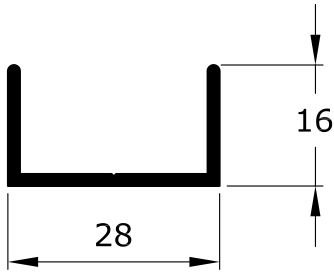

Colour Name	Code
Mill Finish	3-002-300
White	3-002-316
Woodland Grey	3-002-343
Natural Anodised	3-002-311
Black	3-002-317
Stone Beige	3-002-328
Bronze Anodised	3-002-312
Primrose	3-002-319
White Birch	3-002-341
Pottery	3-002-314

Note: All aluminium extrusions or colours are not stocked in all locations, please contact your local branch for availability.

28 X 24 CHANNEL

Features:

- Used as a head guide channel in sliding door applications
- 1.5mm wall thickness
- 4.3m lengths

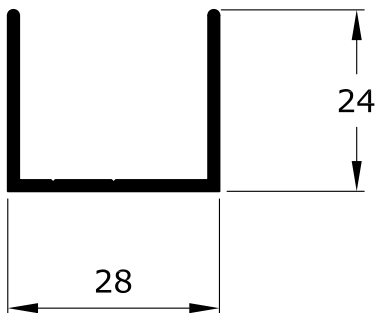

Colour Name	Code
Mill Finish	3-003-300
White	3-003-316
Woodland Grey	3-003-343
Natural Anodised	3-003-311
Black	3-003-317
Stone Beige	3-003-328
Bronze Anodised	3-003-312
Primrose	3-003-319
Mist Green	3-003-329
White Birch	3-003-341
Pottery	3-003-314

Note: All aluminium extrusions or colours are not stocked in all locations, please contact your local branch for availability.

Aluminium Security Systems

ALUMINIUM DIAMOND GRILLE

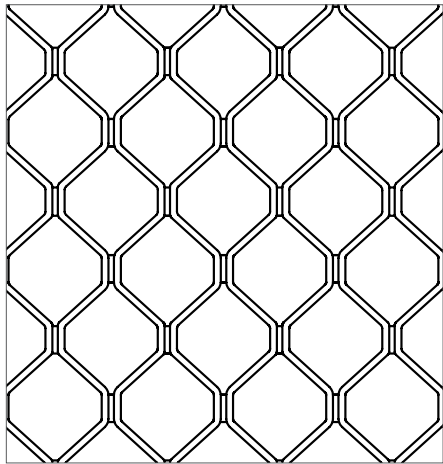

7mm DIAMOND GRILLE

- Used in security and safety window doors and barriers

750 Grille - 750 x 2050mm

Colour Name	Code
Mill Finish	3-005-400
White	3-005-416
Clear Anodised	3-005-411
Satin Black	3-005-417
Woodland Grey	3-005-443
Bronze Anodised	3-005-412
Primrose	3-005-419
Stone Beige	3-005-428
Hammersley Brown	3-005-413
Paperbark/Merino	3-005-421
Pottery	3-005-414
White Birch	3-005-441

830 Grille - 830 x 2050mm

Colour Name	Code
Mill Finish	3-006-400
White	3-006-416
Clear Anodised	3-006-411
Satin Black	3-006-417
Bronze Anodised	3-006-412
Primrose	3-006-419
Stone Beige	3-006-428
Hammersley Brown	3-006-413
Paperbark/Merino	3-006-421
Pottery	3-006-414
White Birch	3-006-441

920 Grille - 920 x 2050mm

Colour Name	Code
Mill Finish	3-007-400
White	3-007-416
Clear Anodised	3-007-411
Satin Black	3-007-417
Woodland Grey	3-007-443
Bronze Anodised	3-007-412
Primrose	3-007-419
Stone Beige	3-007-428
Hammersley Brown	3-007-413
Paperbark/Merino	3-007-421
Pottery	3-007-414
White Birch	3-007-441

1150 Grille - 1150 x 2050mm

Colour Name	Code
Mill Finish	3-003-400
White	3-003-416
Clear Anodised	3-003-411
Satin Black	3-003-417
Woodland Grey	3-003-443
Bronze Anodised	3-003-412
Primrose	3-003-419
Stone Beige	3-003-428
Hammersley Brown	3-003-413
Paperbark/Merino	3-003-421
Pottery	3-003-414
White Birch	3-003-441

1250 Grille - 1250 x 2050mm

Colour Name	Code
Mill Finish	3-004-400
White	3-004-416
Clear Anodised	3-004-411
Satin Black	3-004-417
Bronze Anodised	3-004-412
Primrose	3-004-419
Stone Beige	3-004-428
Hammersley Brown	3-004-413
Paperbark/Merino	3-004-421
Pottery	3-004-414
White Birch	3-004-441

Aluminium Security Systems

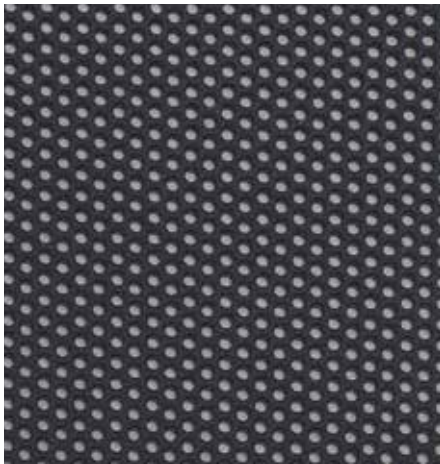

PERFORATED ALUMINIUM SHEET

Features:

- Modern replacement for diamond grille
- Sheet thickness 1.6mm
- Hole apertures 2.2mm
- Excellent corrosion resistance
- Low maintenance

Description	Dimensions (mm)	Colour	Code
Perforated Sheet	750 x 2000	Matt Black Powdercoat	3-103-407
Perforated Sheet	750 x 2400	Matt Black Powdercoat	3-103-417
Perforated Sheet	900 x 2000	Matt Black Powdercoat	3-103-409
Perforated Sheet	900 x 2400	Matt Black Powdercoat	3-103-419
Perforated Sheet	1200 x 2000	Matt Black Powdercoat	3-103-412
Perforated Sheet	1200 x 2400	Matt Black Powdercoat	3-103-422

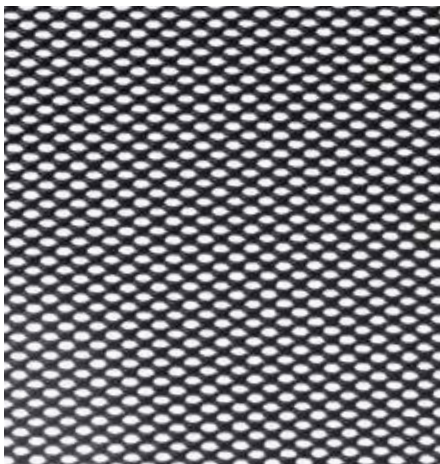

DVA ONE WAY VISION MESH

Features:

- Reduces the vision into the home
- Used with security mesh bead refer to page A.39
- Used with DVA angle, refer to page C.6

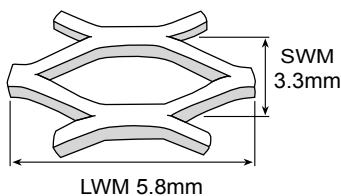

750 Mesh - 750 x 2000mm	
Colour Name	Code
Mill Finish	3-008-200
White	3-008-216
White Birch	3-008-241
Satin Black	3-008-217
Primrose	3-008-219
Stone Beige	3-008-228
Mist Green	3-008-229

820 Mesh - 820 x 2000mm	
Colour Name	Code
Mill Finish	3-008-300
White	3-008-316
White Birch	3-008-341
Satin Black	3-008-317
Primrose	3-008-319
Stone Beige	3-008-328

900 Mesh - 900 x 2200mm	
Colour Name	Code
Mill Finish	3-008-400
White	3-008-416
White Birch	3-008-441
Satin Black	3-008-417
Primrose	3-008-419
Stone Beige	3-008-428

1200 Mesh - 1200 x 2200mm	
Colour Name	Code
Mill Finish	3-008-100
White	3-008-116
White Birch	3-008-141
Satin Black	3-008-117
Primrose	3-008-119
Stone Beige	3-008-118



An innovative new security system



Lincoln Sentry is changing the landscape of the Australian Security Market with the introduction of Sabretooth, an innovative new security system.

Exclusive to Lincoln Sentry, the Sabretooth System sets the benchmark in balancing a great modern look, with an affordable price. Consumers looking to increase the value of their homes by replacing their tired old diamond grille screens, or simply wishing to put a modern spin on their doors and windows, can now do so without hurting their hip pocket by choosing Sabretooth as their security system preference.

* For Dealership opportunities in your area, or for more information, simply call your nearest Lincoln Sentry branch on 1300 551 919





before

after

The Sabretooth System's innovative, patented product utilises an all aluminium construction with a hardened aluminium alloy perforated sheet infill retained into the aluminium frame using 3M adhesive technology. The product has undergone extensive testing and meets all of the performance requirements of Australian Standard AS5039 for security doors and windows. Being all aluminium, the product will look great for many years with a minimum of fuss in terms of maintenance.

The Sabretooth perforated infill allows for clarity of vision, excellent shading and UV reduction characteristics, and allows natural breezes to pass whilst still keeping out those irritating insects.

The product range includes hinged and sliding doors, together with window screens, patio enclosures and privacy screens; all in an extensive range of frame colours. Available only through Lincoln Sentry licensed Sabretooth Dealers; this revolutionary product increases the choices available to consumers and demonstrates true value.

