

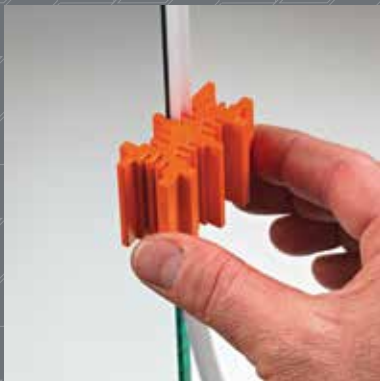

# Glass Edge Seals

> Glass system technology



# Glass Bumper

GLASS BUMPER is a transparent rounded gasket designed to be used on the leading edge of glass doors between 8 to 14mm thick. Positioned down the edge of the glass, GLASS BUMPER provides protection and cushioning on the leading edge of any glass panel.

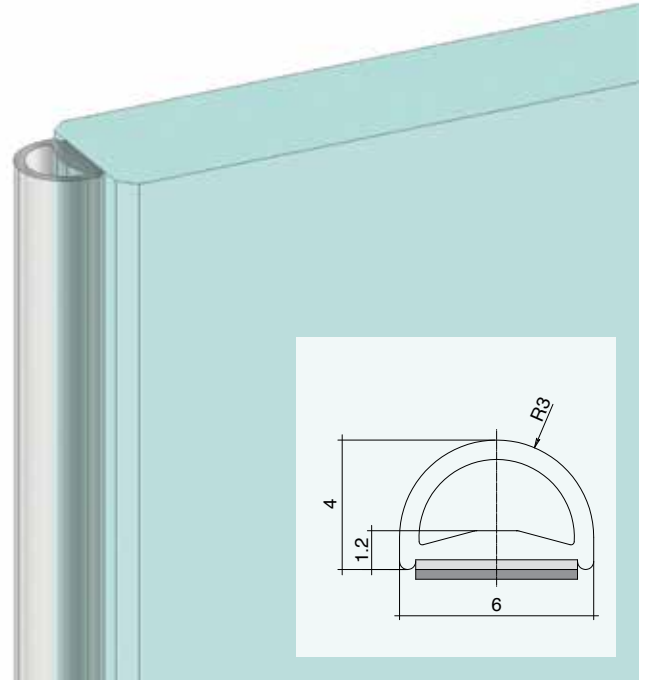

Application:	Features & benefits:
Provides protection to the leading edge of glass panels.	<ul style="list-style-type: none"> <li>• Quick and easy to install</li> <li>• Stylish low profile design with embossed finish</li> <li>• Easy to locate with positioning template</li> <li>• 3M VHB adhesive</li> <li>• Conveniently packaged in a slim line box</li> </ul>

Description	Size	Code
Glass Bumper	12m / Box	<b>3-554-100</b>
Positioning Template		<b>3-554-102</b>
Surface Preparation Wipes		<b>4-080-T510</b>



# Glass Bumper Installation

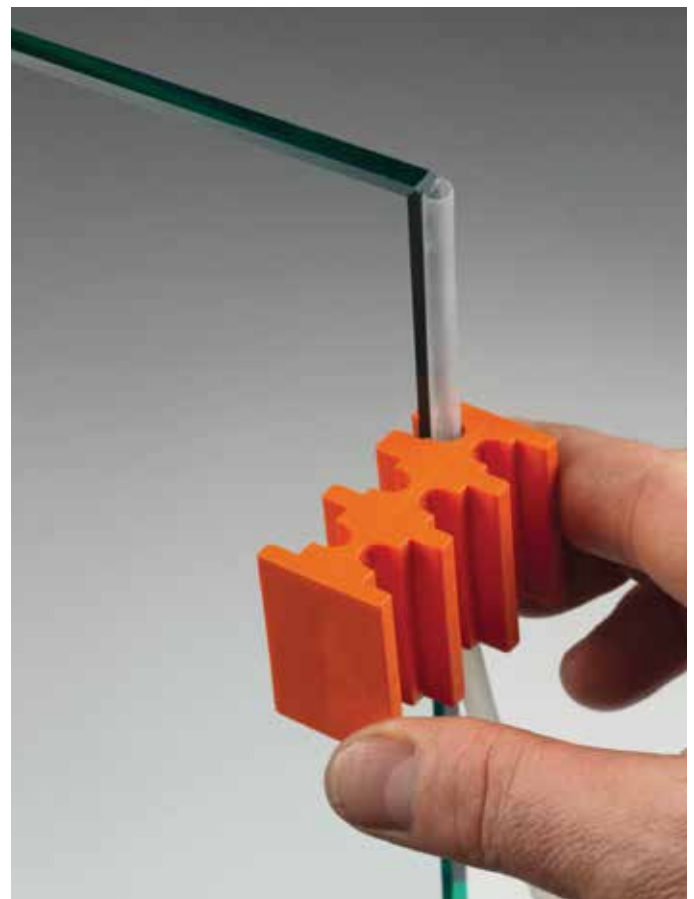
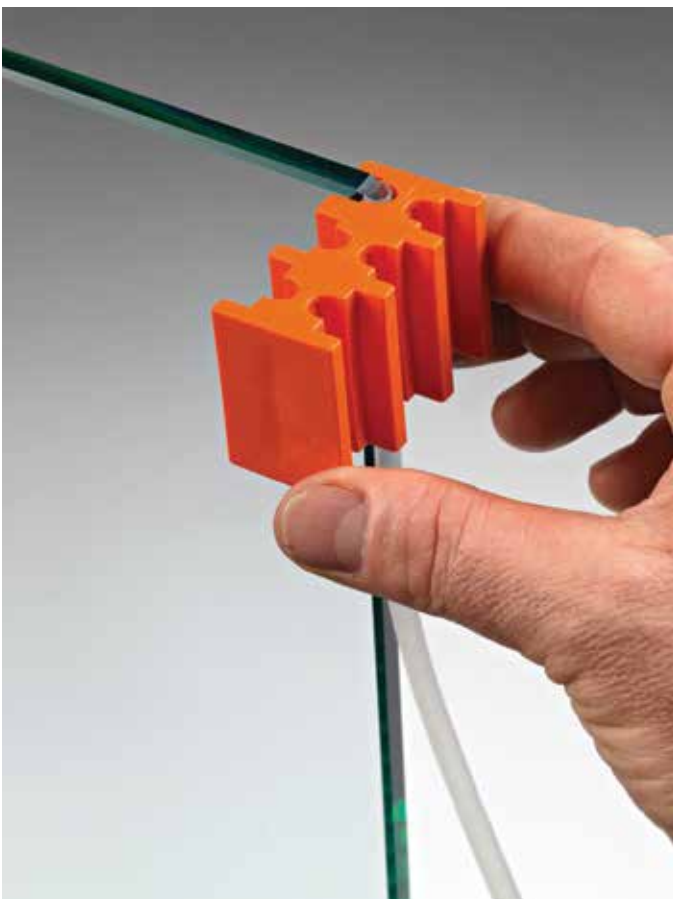
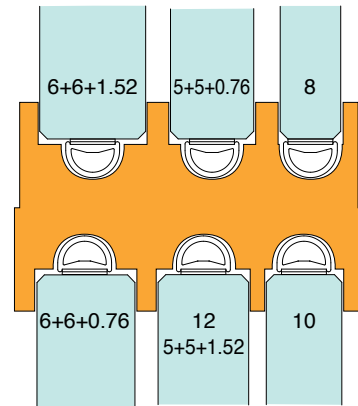

# Glass Lip Seal

GLASS LIP is a patented perimeter seal designed for glass doors and cubicles from 8 to 13.52mm thick. The transparent seal with an adjustable lip can be quickly and easily installed on the fixed panel with the use of the positioning template. The flexible lips can be shortened to fill a gap from between 2.5mm and 7mm.

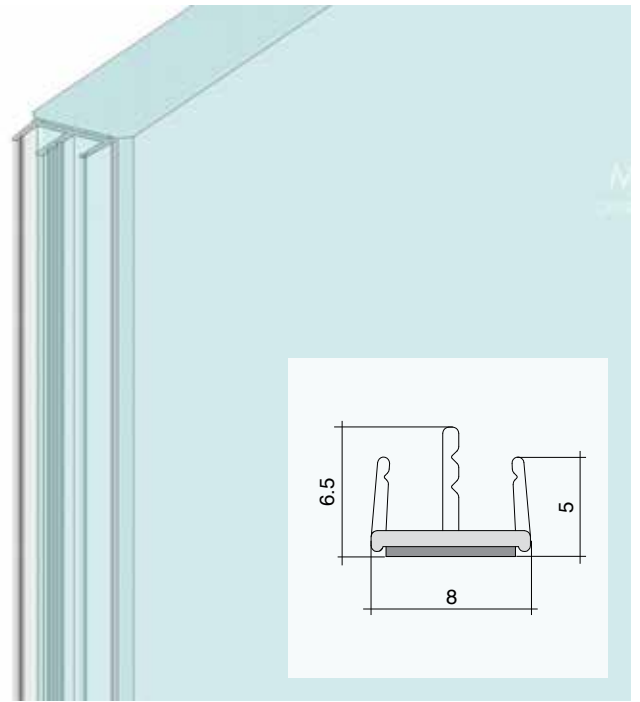

Application:	Features & benefits:
Fills the gaps along the perimeter to keep water, wind, dust, insects, noise and temperature out.	<ul style="list-style-type: none"> <li>Patented system</li> <li>Quick and easy to install</li> <li>Can be shortened to suit gap requirements</li> <li>Easy to locate with positioning template</li> <li>3M VHB adhesive</li> </ul>

Description	Length	Code
Glass Lip Seal	3000mm	<b>3-554-105</b>
Positioning Template		<b>3-554-107</b>
Surface Preparation Wipes		<b>4-080-T510</b>

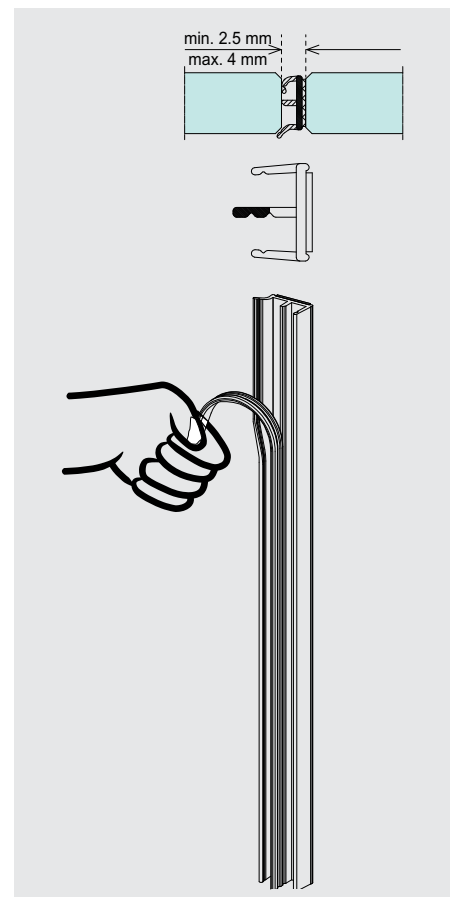
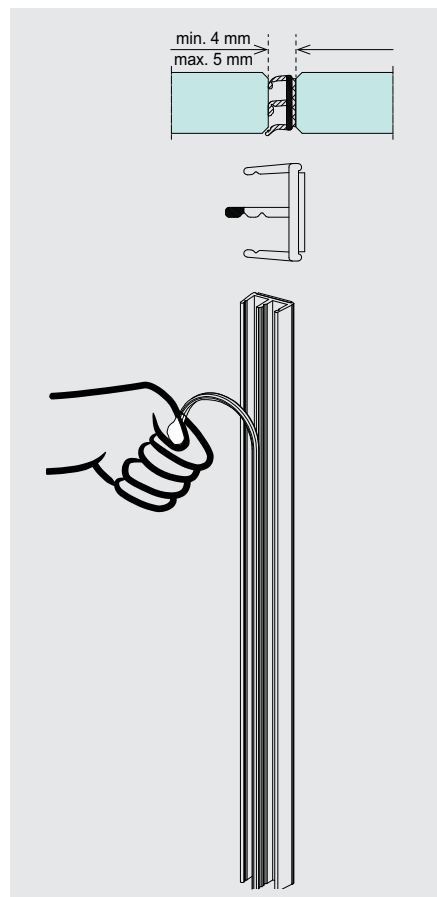
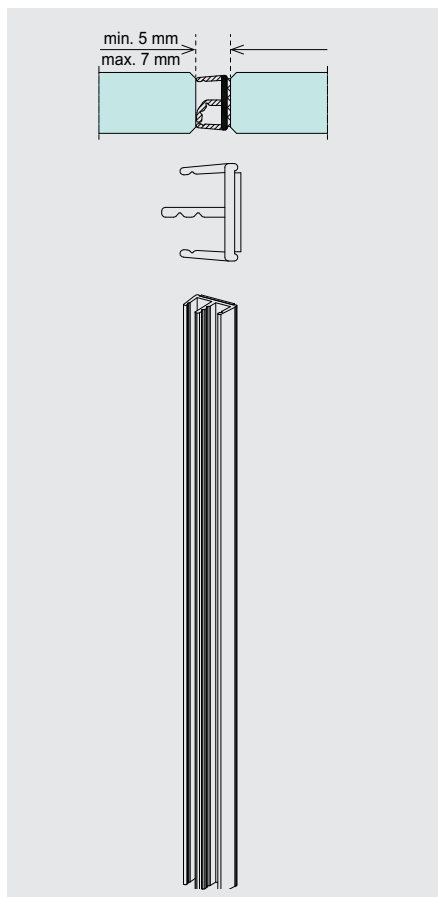

# Glass Lip Seal Installation

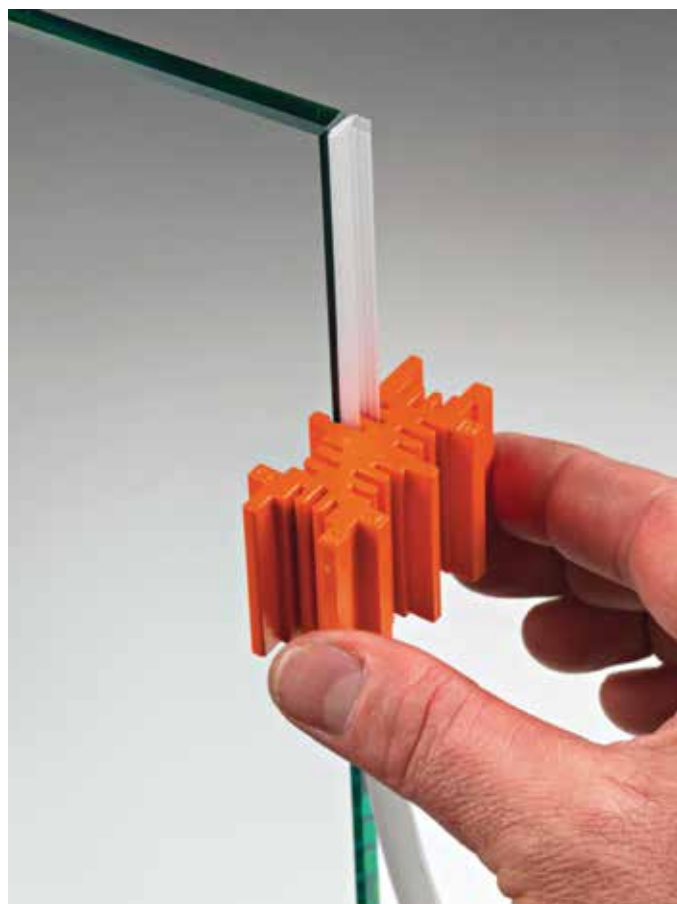
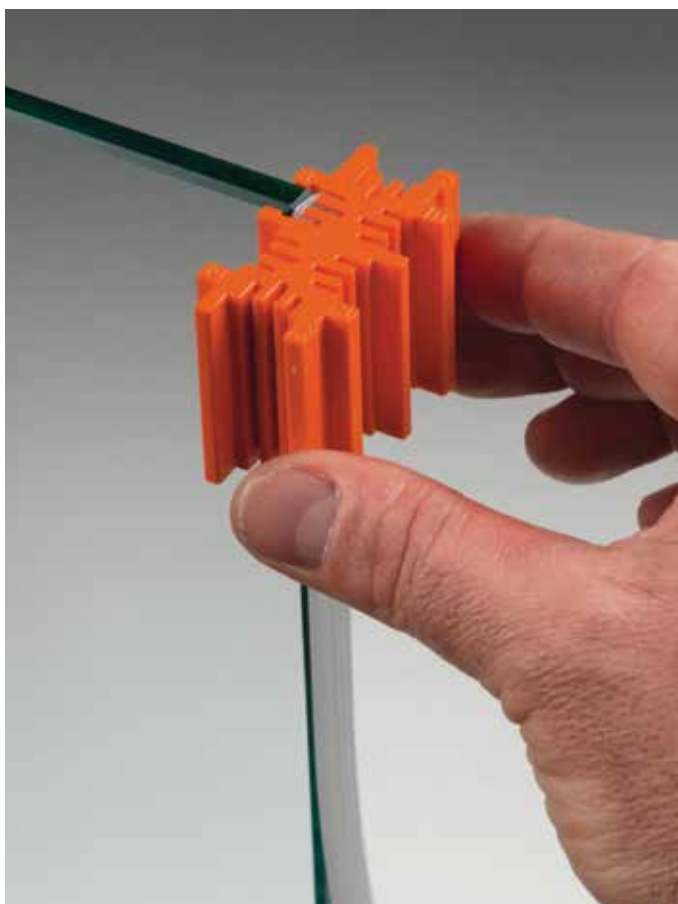
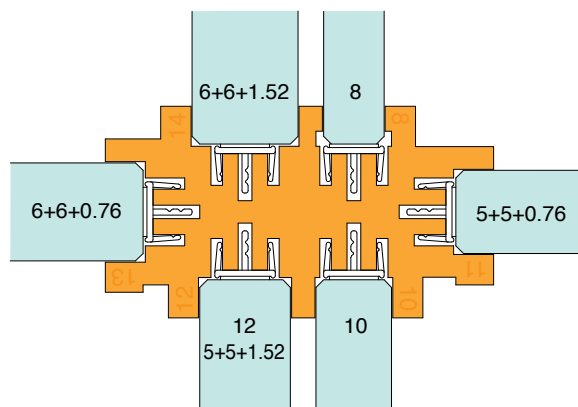

# Glass Lip Slide

GLASS LIP SLIDE is an adhesive seal for sliding glass doors. The transparent seal with an adjustable lip fills the lateral gap between the sliding sash and the fixed panel. The flexible lips can be shortened to fill gaps from between 13mm and 30mm.

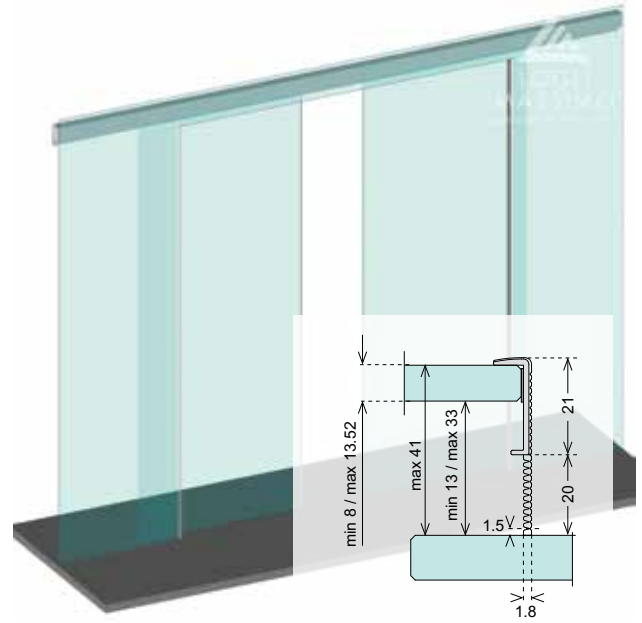

Application:	Features & benefits:
<p>Creates a barrier between sliding and fixed panels to keep out water, wind, dust and insects.</p> <p>Closes off the gap between fixed and sliding panels to prevent potential injury to fingers or hands.</p>	<ul style="list-style-type: none"> <li>• Quick and easy to install.</li> <li>• Easily adjusted on site to suit requirements.</li> <li>• 3M VHB adhesive</li> </ul>

Description	Length	Code
Glass Lip Slide	3000mm	<b>3-554-110</b>
Surface Preparation Wipes		<b>4-080-T510</b>

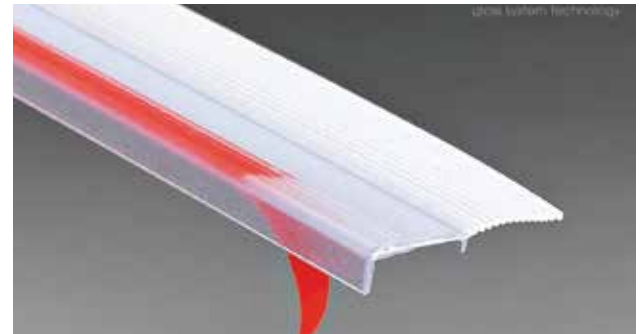



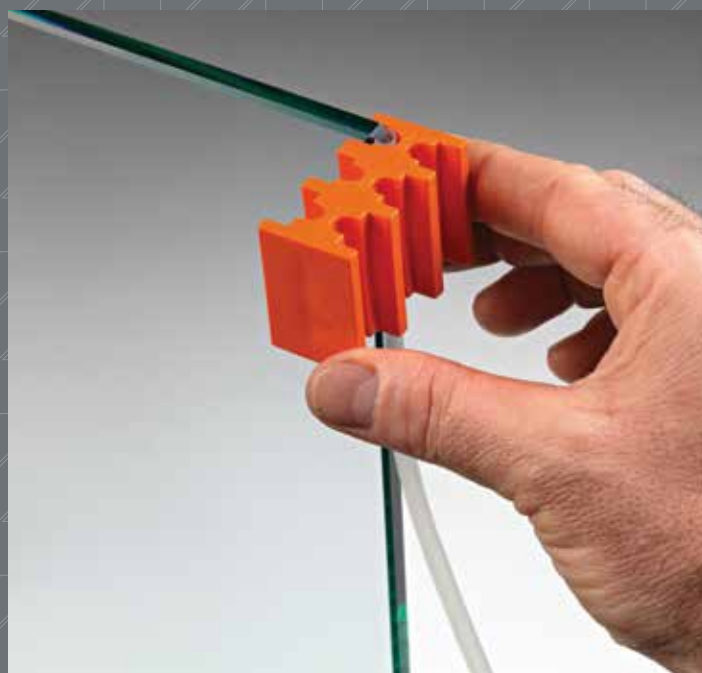

Call your nearest branch on:  
**Ph: 1300 551 919**  
**Fax: 1300 739 656**

[www.lincolnsentry.com.au](http://www.lincolnsentry.com.au)

Scan QR code to find  
your nearest branch



For locations please visit  
<http://www.lincolnsentry.com.au/contact-us/locations>



**LINCOLN**  
S E N T R Y